

SEWING CHEST SINGLE

ШВЕЙНЫЙ СУНДУК SINGLE

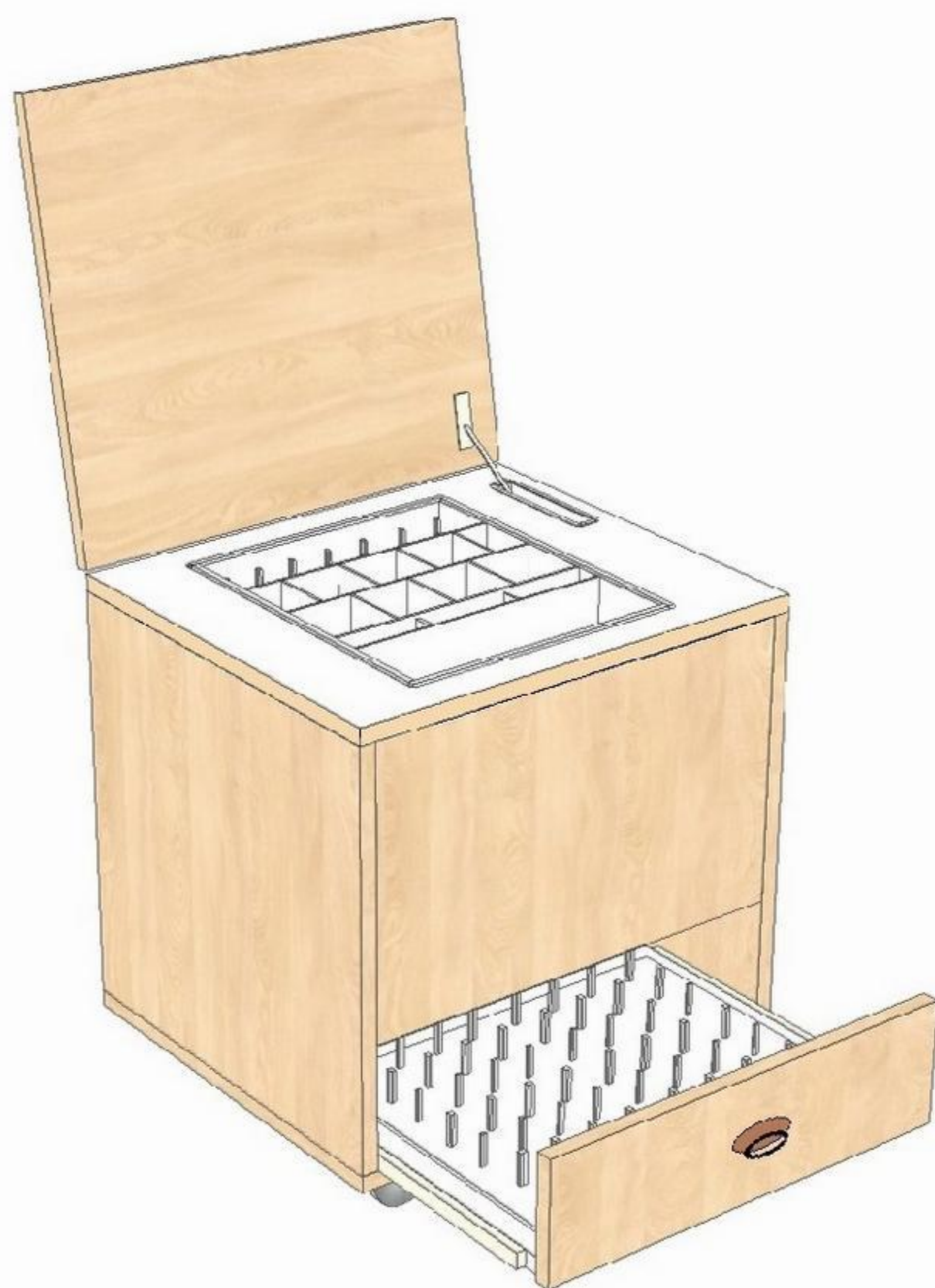

SYMBOLS



ATTENTION

ВНИМАНИЕ



ASSEMBLY & ADJUSTMENT

СБОРКА РЕГУЛИРОВКА



OPERATION

ЭКСПЛУАТАЦИЯ

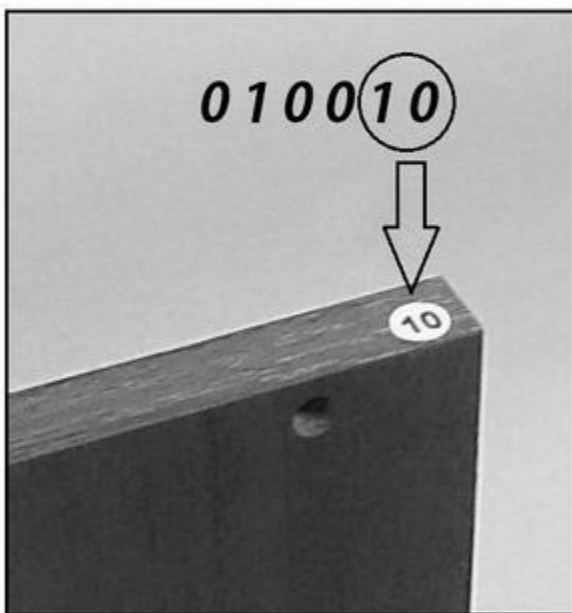

INDICATING MARK

ОБОЗНАЧЕНИЕ

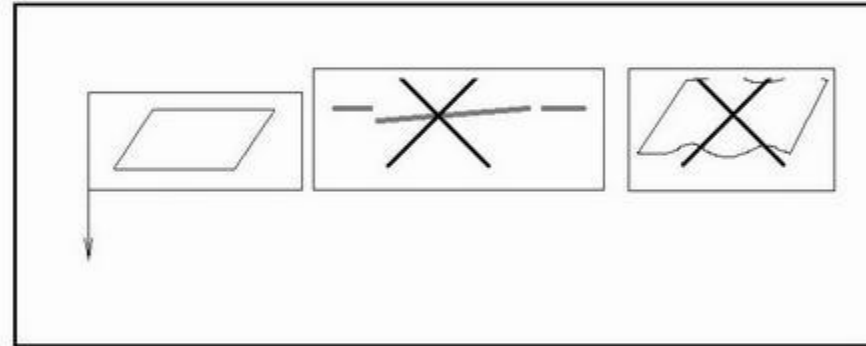









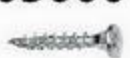



EVEN SURFACE

РОВНАЯ ПОВЕРХНОСТЬ

010001 1x 010002 1x 010003 1x 010004 1x 010006 1x
 010022 1x 010026 1x 010032 1x 010033 1x 010044 1x

<p>1x 020013 CR</p> 	<p>1x 020013 CL</p> 	
<p>1x 020015 DR</p> 	<p>1x 020015 DL</p> 	
<p>1x 020007</p> 	<p>4x 020035</p> 	<p>1x 020037</p> 

<p>030001  3 * 16 4x</p>	<p>030002  3,5 * 16 13x</p>	<p>030003  6,2 * 50 4x</p>	<p>030009  M4 * 20 1x</p>	<p>030011  φ15 4x</p>	<p>030012  φ18 22x</p>
<p>030013  L = 35 22x</p>	<p>030014  φ15 h12 22x</p>	<p>030015  φ8 * 30 26x</p>	<p>030028  3,9 * 16 16x</p>		

<p>1x 050004</p> 	<p>1x 050006</p> 	<p>1x  S4</p>
------------------------------------------------------------------------------------------------------	-------------------------------------------------------------------------------------------------------	--------------------------------------------------------------------------------------------------------------------



S4

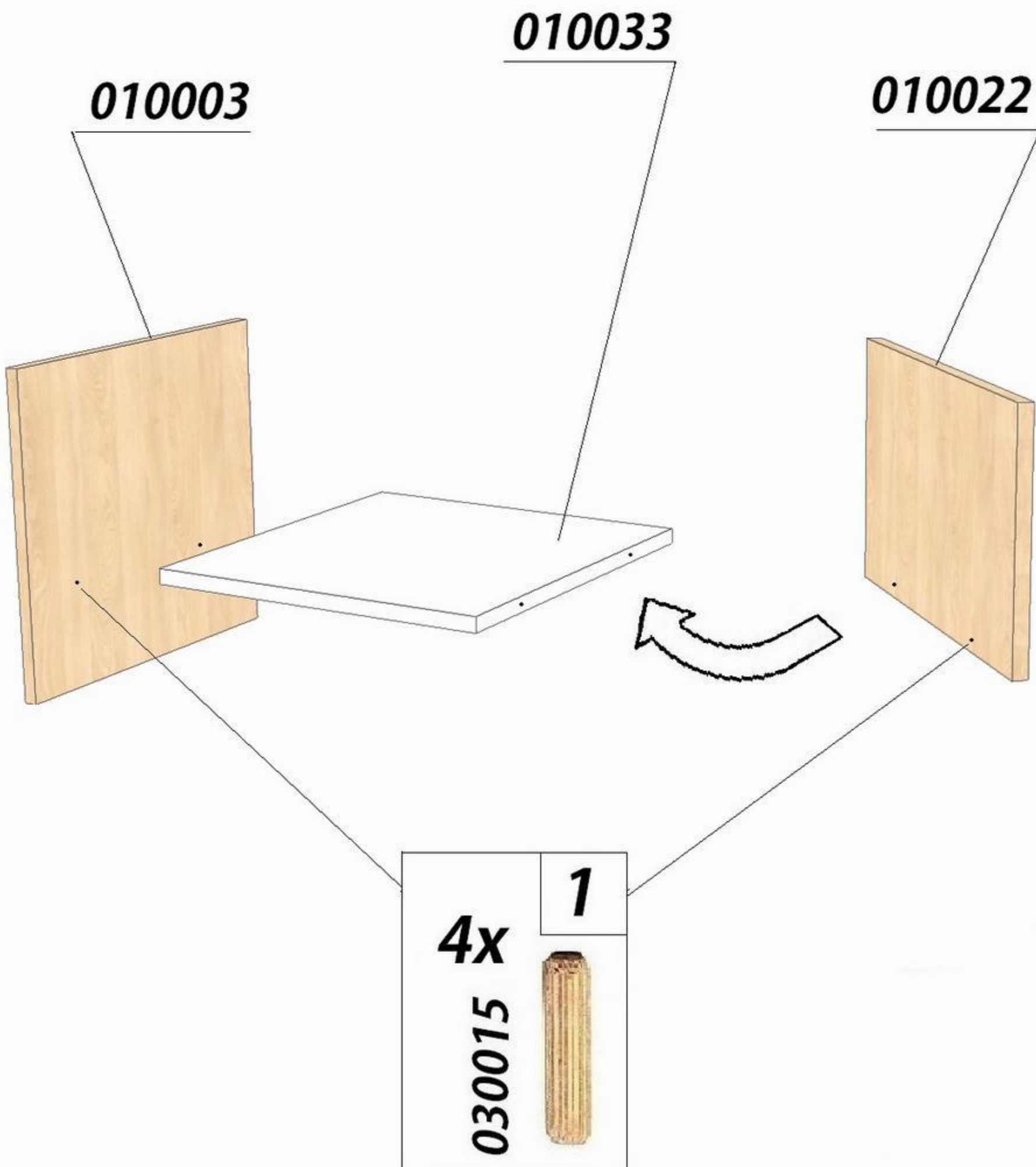

4

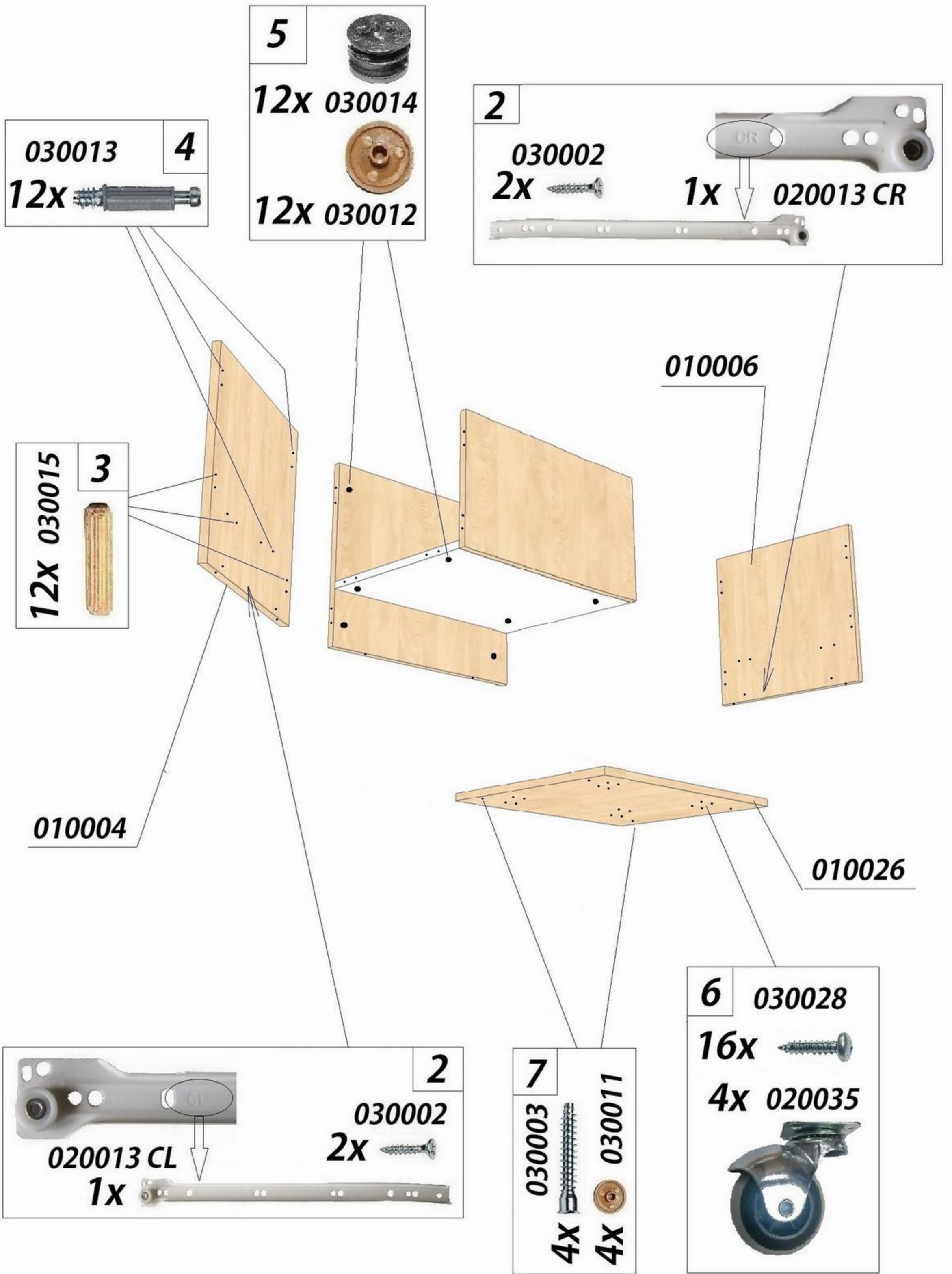

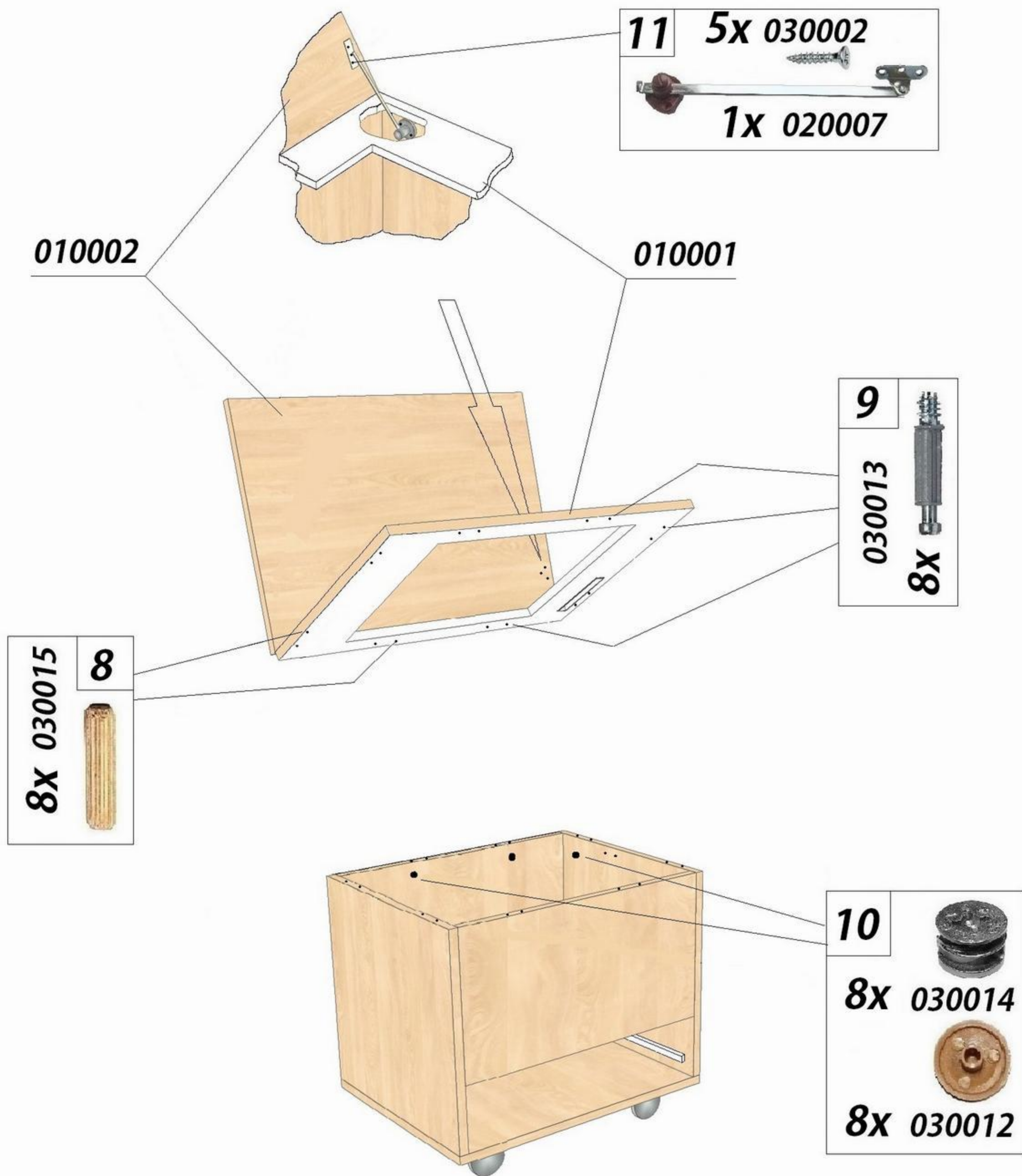

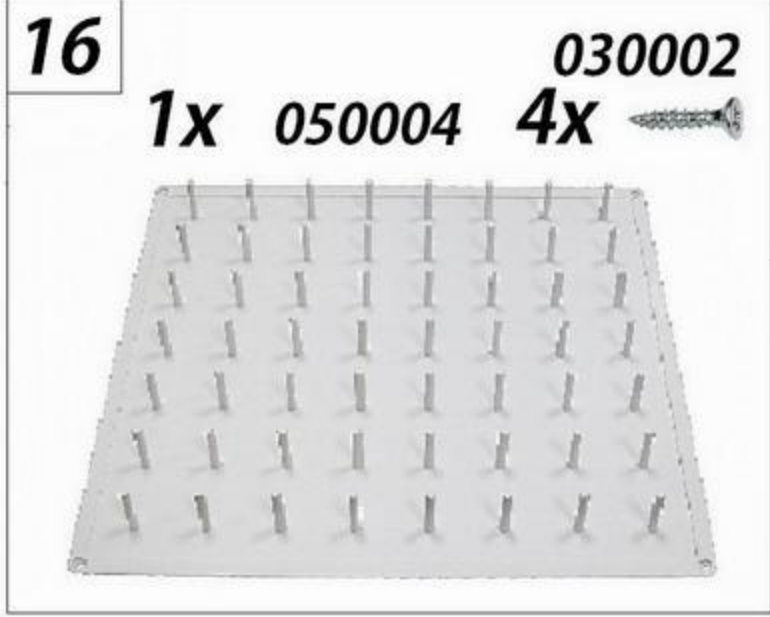
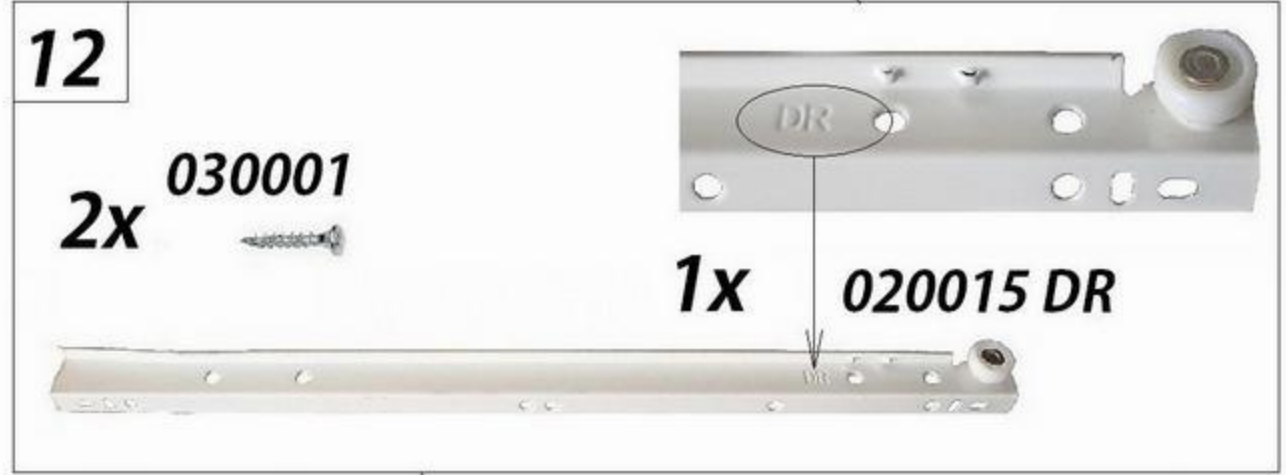

010032

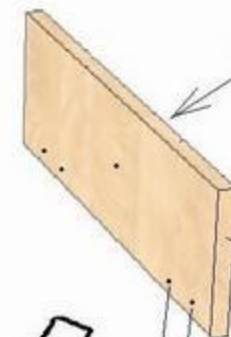
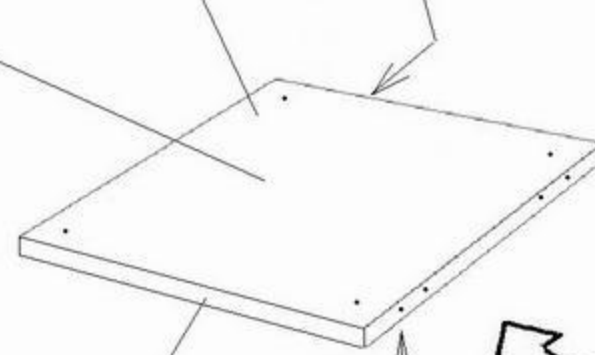

010044

