

 PEGASUS®

# M800

M832: Safety Stitch machines

M852: Overedgers



# M800 Series, a further advanced, best-selling model !

M800 Series, which was developed using all of PEGASUS' state-of-the-art technology, while maintaining cost effectiveness and quality, responds to various needs with a full line of subclasses.



## Point 1

### Excellent oil-blocking features effectively protect your important sewn products from oil stains

In order to prevent damage to your sewn products caused by oil stains, the M800 Series includes excellent oil-blocking mechanisms on many parts of the machine, such as the totally enclosed needle bar chamber, the forced-drain function and the new shaped gasket that has been employed between the oil reservoir and the machine bed, also between the top cover and the machine bed. These features eliminate stain removing operations, increasing productivity and quality.

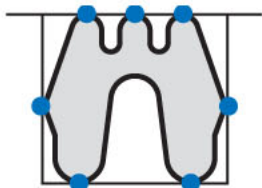

Sectional view of gasket

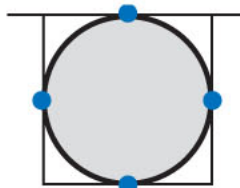

Before

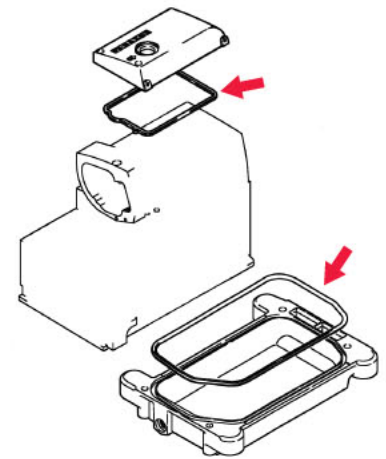
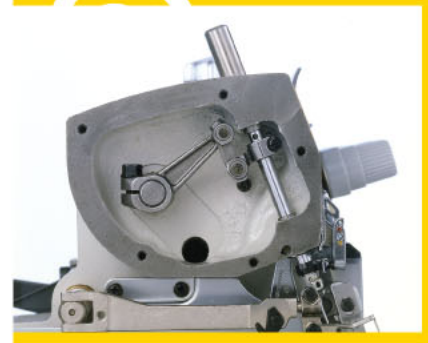

## Point 2

### Achieves a maximum machine speed of 7,000 rpm, resulting in production increases

An aluminum rod has been employed for the main shaft mechanism. This feature reduces weight, achieving high speed and also decreasing vibration, noise and heat generation.





### Point 3

#### **Introduction of the rustproof needle plate**

This needle plate is surface-treated as a rust prevention measure. Thanks to this feature, the needle plate is not damaged by fabrics processed with chemical agents and/or dyes.



### Point 4

#### **Includes more versatile machines for various applications and purposes**

The M800 Series can respond to the use of different kinds of fabrics and/or sewn products by changing the position of the shaft of the presser arm. Therefore, you can pick out a machine that meets your needs, from a full line of subclasses. In addition, this series can use PEGASUS' conventional machine parts and labor saving devices (note that some special parts are needed).



# Other features

## ■ Operator-friendly safety design

The newly designed belt cover encloses the belt completely.

The eye guard has been improved in order to cover not only the conventional area but also the area around the left side of the needle.

These features increase safety.

The new design also decreases noise and vibration, enhancing the work environment and reducing operator fatigue.



## ■ Excellent performance that ensures uniform quality of sewn products

Equipped with a needle/thread cooler (HR device) and a movable needle guard.

The HR device protects fabric from heat generated on the needle point when the machine runs at high speed.

The movable needle guard receives the needle only when needed, so it prevents stitch skipping and lower looper wear.

Thanks to these features, uniform quality is achieved.

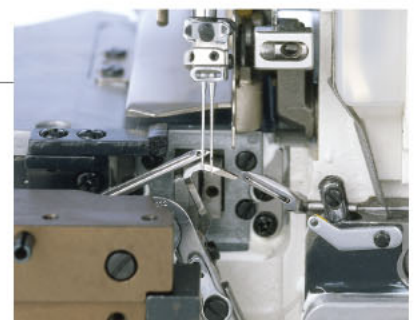
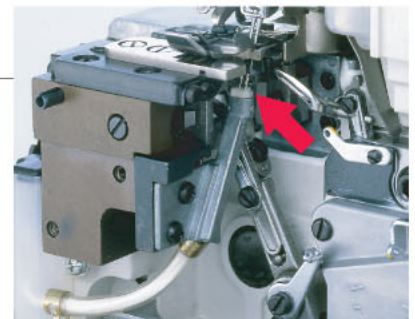
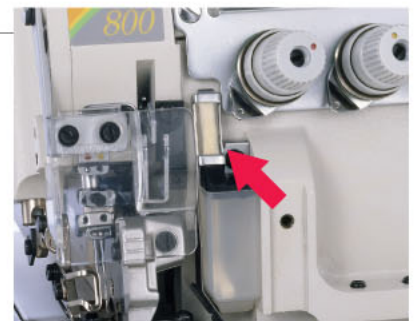

## ■ User friendly design with ease of operation

The stitch length and the differential feed ratio can be changed easily. No tool is needed. Machine maintenance can be also conducted effortlessly, such as adjustments of the front-to-back tilt of the feed dog, threading and cleaning the machine. This user friendly design improves operation efficiency.

Pushbutton type stitch length adjustment



Lever type differential feed adjustment



Cloth plate combined with the side cover that can be simultaneously opened



Easy-to-handle presser bar with a lever



Oil circulation checking window



Oil sight window for checking oil level



# M800 Devices

## ■ Thread chain cutter (KS/KH)

Thread chains are trimmed as soon as they are sucked up by air suction. There is no need to cut thread chains using scissors. This device dramatically increases operation efficiency.

### **Vertical type vacuum chain cutter:KS**

The suction inlet is located beside the needle. This type of thread chain cutter is mainly employed for overedgers.

### **Flat type vacuum chain cutter:KH**

The suction inlet is located right in back of the presser foot. Therefore, this type of thread chain cutter smoothly sucks and cuts wide, extra weight or woolen thread chains and thread chains produced from safety stitch machines.



## ■ Tape/thread chain cutter (TK)

Pressing the switch lowers the knife, and then tapes and/or thread chains are cut. No scissors are needed. Operation efficiency is greatly increased. An electric finger switch and a pneumatic knee switch are available. You can select either of the two according to your needs.



## ■ Pneumatic lint collector (New LC device)

This device powerfully sucks up cutting waste and/or dust produced during sewing, so the waste and dust are not collected around the knives and inside the front cover. Thanks to this device, the operators always work under clean and healthy conditions. In addition, daily maintenance is easy, preventing various kinds of machine trouble caused by the cutting waste and /or dust, such as oil stains.





## M800 Series Subclasses

### Safety stitch machines: M832

Seam	Type of machine	Model	No. of needles	No. of threads	Needle space	Overedge width	Max. Stitch length	Differential feed ratio	Foot lift	Max. machine speed	Needle size	Remarks
Plain seaming light to medium weight fabrics												
①	Such as casual shirts	M832-38	2	5	3	4	3.8	0.7-1.7(*)	5.5	7,000	DCx27 14	
①	Wide overedging, such as cotton pants	M832-70	2	5	5	5	3.8	0.7-1.7(*)	5.5	7,000	DCx27 14	
Plain seaming heavy to extra heavy weight fabrics												
①	Such as jeans	M832-86	2	5	5	6	5.3	0.6-1.3	5.5	5,500	DCx27 21	With caterpillar foot
3-needle versatile machines												
①②⑤⑥	Versatile machine for 1-needle, 2-needle overedging, safety stitching	M832-355	3	6	3+2	4	3.8	0.7-1.7(*)	5.5	6,000	DCx27 11	

### Overedgers: M852

Seam	Type of machine	Model	No. of needles	No. of threads	Needle space	Overedge width	Max. Stitch length	Differential feed ratio	Foot lift	Max. machine speed	Needle size	Remarks
1-needle blindstitch hemming												
③	Such as T-shirts	M852-01	1	3	-	4	3.8	0.7-1.7(*)	5.5	7,000	DCx27 9	
Plain seaming light to medium weight fabrics												
④⑤	2-needle plain seaming, attaching tape and joining shoulders, such as T-shirts, polo shirts	M852-13	2	4	2	6	3.8	0.7-1.7(*)	6	7,000	DCx27 9	With presser foot for attaching tape
⑥	1-needle plain seaming, such as T-shirts, polo shirts	M852-17	1	3	-	4	3.8	0.7-1.7(*)	5.5	7,000	DCx27 9	
Turn-down hemming												
⑦	Such as handkerchiefs, scarves	M852-16S2	1	3	-	1.5	3.8	0.7-1.7(*)	5.5	6,500	DCx27 11	

\*Differential feed ratio 1:2 is available with maximum main feed dog movement amount at 2.9mm. Reading 6 is the upper limit for the differential feed adjusting lever with main feed dog movement amount at 2.9mm.



Model	Fabric weight			Chart													
	Light	Medium	Heavy	T-shirts	polo shirts	athletic wear	under wear	briefs	shorts	lingerie	swimsuit	Y-shirts blouse	slacks	jeans	casual	child, baby clothes	handkerchief
M832																	
M832-38																	
M832-70																	
M832-86																	
M832-355																	
M852																	
M852-01																	
M852-13																	
M852-17																	
M852-16S2																	

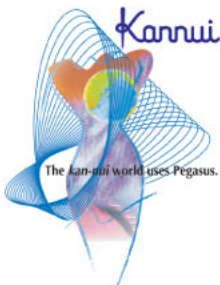

**PEGASUS SEWING MACHINE MFG.CO.,LTD.**  
 5-7-2, Sagisu, Fukushima-ku, Osaka 553-0002, Japan  
 Phone: 81-6-6458-4739 Telefax: 81-6-6454-8785  
<http://www.pegasus.co.jp>

※The specification and/or appearances of the equipment described in this catalog is subject to change because of modification without previous notice.

